

CPAP Device

# User Manual

**SOMNUS® CPAP Device Series**

DM28-20C-G

DM28-20A-W

DM28-20A-WP



## Preface

Thank you for purchasing the CPAP Device manufactured by Yamind.

Read and understand the entire operator's manual before operating this device. Store this operator's manual properly for future reference.

Product name: CPAP Device

Model: DM28-20C-G, DM28-20A-W, DM28-20A-WP

Safety classification: class II, type BF protection against electric shock

Date of manufacture: see product label

## Contact Information of Service Department



Legal Manufacturer: Shenzhen Yamind Medical Technology Co., Ltd.

Room 1102, 11th Floor, Building B, Hightech Part 2, Road Guangqiao, Tianliao Community, Yutang Street, Guangming District, Shenzhen, PEOPLE'S REPUBLIC OF CHINA.



Llins Service & Consulting GmbH

Obere Seegasse 34/2, 69124, Heidelberg, Germany

Zip Code: 518107

24-hour service hotline: 400-990-2120

Tel.: 86 -755 26016902

Fax: 86 -755 26746162

Email: [yamind@yamind.com.cn](mailto:yamind@yamind.com.cn)

Website: <http://www.yamind.cn/>



Distributed By: CPAP STORE USA LLC

Mail: [info@cpapstoreusa.com](mailto:info@cpapstoreusa.com)

Phone: (888) 512-7278

Fax: (800) 439-3194

## Quality Guarantee

For faults caused by materials and manufacturing problems, Yamind offers a 2-year warranties on the host and a three-month warranty on accessories such as the tube, mask, and heated humidifier. The warranty period is counted from the date of shipment to the customer. Within the warranty period, Yamind offers repair service without charge in accordance with warranty obligations.

If you require the electrical diagram or component list of the device in special situations (such as maintenance or connection to other devices), contact us. We will provide you with part of or the entire electrical diagram of the product based on your requirements.

You can get repair service without charge only after producing the warranty card filled in upon purchase of the product.

## Copyright

©Shenzhen Yamind Medical Technology Co., Ltd. All rights reserved. This document contains proprietary information of Shenzhen Yamind Medical Technology Co.,Ltd. (hereinafter referred to as Yamind). No part of this document may be reproduced, copied, modified, disclosed, or transmitted in any form or by any means without prior written consent of Yamind. This document is intended for users of Yamind equipment, whom are authorized to use this document as they purchase Yamind equipment. Unauthorized persons are not allowed to use this document.

All information in this document does not constitute a warranty of any kind, express or implied, including, but not limited to, the implied warranties of merchantability and fitness for a particular purpose. Every effort has been made in the preparation of this document to ensure accuracy of the contents. However, Yamind assumes no liability or responsibility for any errors or omissions in the contents of this document. Yamind reserves the right to improve any products to enhance product reliability, functionality, or design.

## Declaration

This user manual may be modified without notice.

Yamind reserves the right of final interpretation of this user manual.

The pictures in this user manual are indicative only. If there is inconsistency between the pictures and the actual product, the actual product shall govern. Do not use the pictures for other than intended use.

Yamind is only responsible for the normal working of the device and will not give any commitment to patient illness condition. Please consult your doctor before use and obey the user instructions.

Yamind shall be responsible for the safety, security, and performance of the product only when all of the following conditions are met:

- The assembly, re-commissioning, extension, modification, and repair of the product are performed by the authorized personnel of Yamind.
- The product is operated based on this user manual.
- Related electrical devices comply with CE standards.

The manufacturer will not be responsible if the user violate the requirements, which leads to malaise on body or any other injury.

---

# Contents

---

<b>1 Overview</b> .....	<b>1</b>
1.1 Intended Use.....	1
1.2 Product Description .....	1
1.3 Operation Theory .....	2
1.4 Safety Information.....	2
1.4.1 Warnings .....	2
1.4.2 Cautions .....	3
1.4.3 Contraindications .....	4
1.4.4 EMC .....	5
1.4.5 Protective Measures .....	5
1.5 Symbols .....	5
1.6 Disposal .....	6
<b>2 Installation and Configuration</b> .....	<b>7</b>
2.1 Device Composition .....	7
2.2 Device Description .....	7
2.3 Installation.....	10
2.4 Home Screen .....	11
<b>3 Parameter Settings</b> .....	<b>13</b>
3.1 Ramp Time.....	13
3.2 Humidity Level .....	13
3.2.1 Setting the Humidity Level .....	13
3.2.2 Stop warming or cooling.....	14
3.3 Preheating.....	14
3.4 User Setup.....	14
3.5 Advanced Setup .....	17
3.6 Alert.....	19
3.6.1 Parts Reminder .....	19
3.6.2 Alarm Settings .....	20
3.6.3 About The Device .....	21
<b>4 Routine Use</b> .....	<b>22</b>
4.1 Treatment Steps .....	22
4.2 Viewing Data .....	23
4.2.1 Day Data .....	23
4.2.2 Detail .....	24
4.3 Alarm.....	25
<b>5 Cleaning and Maintenance</b> .....	<b>26</b>
5.1 Daily Cleaning.....	26

5.2 Weekly Cleaning .....	27
5.3 Disinfection .....	28
5.3.1 Disinfecting the Device.....	28
5.4 Transfer the Device.....	28
<b>6 Service and Repair .....</b>	<b>29</b>
<b>7 Troubleshooting .....</b>	<b>30</b>
<b>Appendix A Specifications .....</b>	<b>32</b>
A.1 Basic Specification .....	32
A.2 Technical Specification .....	33
<b>Appendix B Key Components .....</b>	<b>36</b>
<b>Appendix C Terms .....</b>	<b>37</b>
<b>Appendix D EMC Requirements.....</b>	<b>38</b>
<b>Appendix E Packing List.....</b>	<b>42</b>

# 1 Overview

## 1.1 Intended Use

The product provides noninvasive ventilation for patients with obstructive sleep apnea. It is indicated for adult patients weighing more than 30kg and can be used in homes and hospitals. Not be used for life support, not for central sleep apnea.

### CAUTION

- This device is a portable device for home use. It can be used only after completion of treatment parameter settings under the instruction of a licensed physician.
- The clinical manifestations of obstructive sleep apnea syndrome (OSAS) are mainly: snoring, somnolent at day, sleep apneas, excessive urination at night, headache as well as other complications.

## 1.2 Product Description

The information of each model of the CPAP Device is shown in Table 1-1.

**Table 1-1 Model Information**

Model	Mode	Pressure Range (hPa)	Extended Features
DM28-20C-G	CPAP	4.0~20.0	None
	APAP		
DM28-20A-W	CPAP	4.0~20.0	None
	APAP		
DM28-20A-WP	CPAP	4.0~20.0	Wi-Fi
	APAP		

The treatment mode of the CPAP Device is shown in Table 1-2.

**Table 1-2 Mode Description**

Mode	NOTE
CPAP	Continuous Positive Airway Pressure. The device provides continuous positive pressure airflow.

Mode	NOTE
APAP	Automatic Continuous Positive Airway Pressure. The device can adjust and find the best curing pressure automatically according to the sleep condition of patient.

## 1.3 Operation Theory

OSAS usually performs as airway obstruction, disturbance in respiration, which may cause respective complications. The CPAP Device uses dedicated air compressor to compress filtered air from the surrounding environment to produce continuous positive pressure. The positive pressure is transported to the patient through a breathing tube. The upper airway of the patient is kept open under the positive pressure so that the patient can breathe normally. The working principle of the device is illustrated by Figure 1-1.

Figure 1-1 Operation Theory

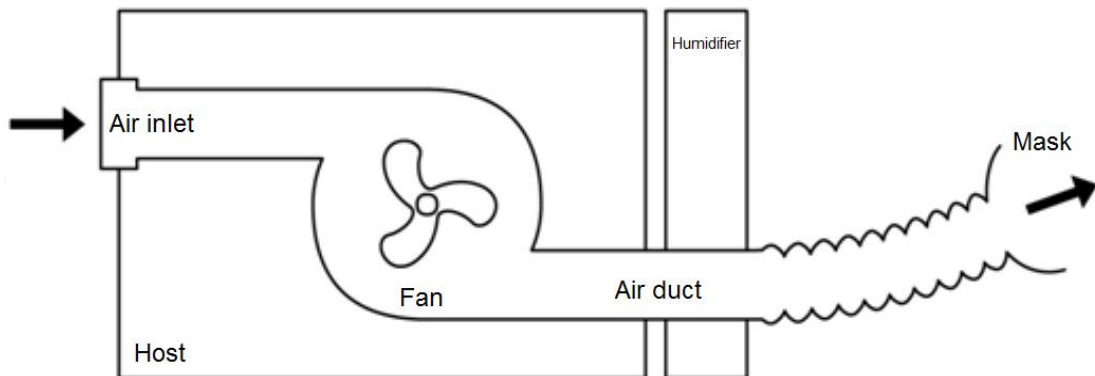

If the positive pressure is set to an excessively low value, the effect of treatment will be affected; if the positive pressure is set to an excessively high value, the patient will feel uncomfortable. Therefore, the patient must undergo pressure titration in hospital before using the device. A licensed physician will present a report on usage pressure and perform pressure titration for the patient.

The CPAP Device uses a built-in humidifier to increase the temperature and humidity of the breathing air to prevent the nasal mucosa from drying out, ensuring user comfort. The CPAP Device is operated by using the display screen and control buttons on top of the ventilator. The functions are adjustable.

## 1.4 Safety Information

### 1.4.1 Warnings

- Read and understand the entire user manual before operating this device.
- This device is not intended for life support.
- This device can be used only after completion of treatment parameter settings under the instruction of a licensed physician.



- The instructions in this manual are not intended to supersede established medical protocols.
- The use of accessories other than those specified may have an adverse effect on device functions and may even present a safety hazard.
- When connecting the power adapter, check whether the plug is connected to the device's power interface properly.
- This device is not suitable for use in the presence of a flammable anaesthetic mixture in combination with oxygen or air.
- In order to reduce the possibility of repeated inhalation of carbon dioxide (CO<sub>2</sub>), patients should be aware of:
  - Use the accessories (such as the mask, tube, and power adapter) recommended or provided by Yamind.
  - Do not block the vent holes of the mask. If the vent holes are blocked, the patient will repeatedly breathe in exhaled air, which may cause suffocation.
  - Take off the mask in the case of power failure or in the unlikely event of fault conditions.
- Discontinue use if you notice any exceptions of the device, such as significant external damage, liquid ingress, excessively hot output air, or unusual sounds.
- Do not perform repair or maintenance when the device is operating.
- It can be unsafe to interconnect the device with other equipment not described in this manual.
- Bundle or place the cables and hose properly to avoid strangulation due to excessive length.
- Device and system should not be close to other devices or stack. Or it should be observed and verified that it can work normally under his setting, if it has to be closed to other device or stack.
- It's possible to lead to the increasing of the electromagnetic radiation or the decreasing of noise immunity of device and system, accessory and electric cable which are out of stipulation are used, except for the electric cable which are sold as spare parts of internal components by the manufacturer of the device and system.
- Nebulisation or humidification can increase the resistance of breathing system filters and the operator must monitor the breathing system filter frequently for increased resistance and blockage to ensure the delivery of the therapeutic pressure. Failure to use use a mask or accessory that minimizes rebreathing of carbon dioxide or permits spontaneous breathing can cause asphyxiation.
- Combinations with medical devices other than recommended can alter the performance of the equipment.
- If humidity performance of the device can be compromised when used outside the specified ambient temperature range or humidity range.
- Do not place the device in a dirty environment, which can cause internal bacteria in the instrument.
- If the instrument has expired, it can no longer be used. If it continues to be used, the consequences will not be borne by Yamind.

## 1.4.2 Cautions

- Before turning on the device, make sure the power supply is steady and meets the requirements.
- The use of communications equipment, electromechanical equipment, or MRI equipment near this device may cause interference to this device and should be kept at a distance.
- Do not disassemble or repair the device without authorization. Contact your device supplier if the device is damaged.

- Do not immerse the host in any fluids or place the host in an excessively hot and humid environment.
- Disconnect the power cord when the device is not in use.
- In the home healthcare environment that can unacceptably affect the basic safety and essential performance of the device, please make sure to keep the device away from:
  - lint, dust, light (including sunlight), etc.
  - pet, pest and children.
- Irregular sleep, drinking, fat, obesity, hypnotic or sedatives may aggravate the symptoms.
- Empty the water in the humidifier water tub during handling and storage.
- In order to ensure normal and safe use, the air intake of the instrument cannot be covered or blocked or contaminated.
- Please make sure you have a good understanding of all aspects of the product and get the maximum benefit during using this product. It is useful to have a special training according to the manufacture's training manual.
- Masks, breathing tube and water tub can't be used by others after you've used them, which can cause cross-contamination.

### 1.4.3 Contraindications

#### **Absolute Contraindications**

The device is prohibited to use, if patient is among any case below:

- Pneumothorax, pneumomediastinum
- Cerebrospinal fluid leakage, craniocerebral trauma, intracranial trauma or pneumocephalus
- Shock from various causes that has not been corrected
- Epistaxis
- Upper gastrointestinal bleeding that has not been effectively controlled
- Coma or concomitant awareness disorder that cannot cooperate or receive mask treatment
- Obstructive vocal cord polyps

#### **Relative Contraindications**

Patients with any of the following conditions are advised to inform the doctor before using this product (this equipment may only be used for continuous positive pressure ventilation treatment if the patient is examined and diagnosed by the doctor; the patient must be under special care and regular monitoring of the doctor during its use):

- Severe coronary heart disease with left heart failure
- Otitis media inflammation acute period
- Excessive respiratory secretions and cough weakness
- Weak spontaneous breathing
- Tracheal intubation (nasal or oral) and tracheotomy
- Severe nasal congestion from various causes
- Lung bullae
- Breathing mask allergy

## 1.4.4 EMC



### WARNING

- Device and system should not be close to other devices or stack. Or it should be observed and verified that it can work normally under his setting, if it has to be closed to other device or stack.
- It's possible to lead to the increasing of the electromagnetic radiation or the decreasing of noise immunity of device and system, accessory and electric cable which are out of stipulation are used, except for the electric cable which are sold as spare parts of internal components by the manufacturer of the device and system.
- Even if other equipment meets the corresponding national standards of the launch requirements, the device may still be interfered.

### CAUTION

- This device complies with the electromagnetic compatibility requirements of YY0505.
- Install and use the device based on the electromagnetic compatibility information provided in **Appendix D EMC Requirements**
- Portable and mobile RF communication equipment can affect the performance of the device. Avoid strong electromagnetic interference (such as near cell phones, microwave ovens, etc.) when using the device.
- For details about the EMC requirements, see **Appendix D EMC Requirements**

This device supports wireless communication, and the electromagnetic compatibility information is as follows.

- Transmitting and receiving frequency range of wireless communication: 2.412 GHz~ 2.472 GHz
- Cable information

No.	Cable Name	Cable Length(m)	Whether Shielded
1	Power adapter output line	1.5	No
2	Power cord	1.5	No

## 1.4.5 Protective Measures







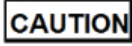

- In the course of using the ventilator, if any abnormal chest discomfort, shortness of breath or severe headache occurs, please inform the doctor immediately.
- If the mask irritates or damages the skin, please refer to the mask user manual for appropriate measures.

## 1.5 Symbols

The symbols that may be found in this document are defined as follows.

Symbol	Description
	Alerts you to injury if not operating based on the description under this symbol.
	Alerts you to device damage if not operating based on the description under this symbol.

You may find the following symbols of the device:

Symbol	Description
	Caution, consult accompanying documents.
	Serial No.
	Date of manufacture
	Manufacturer
IP21	Ingress protection
	Type BF applied part
	Refer to instruction manual
	Non-ionizing radiation symbol
	European CE declaration of conformity
	Authorized Representative in the European Community

## 1.6 Disposal

The user of the device is required to dispose of the device and related packing materials based on applicable national laws and regulations when the device reaches the end of service life. Observe the following disposal instructions unless otherwise specified:

- Send the device that has reached the end of service life to a recycle center. The recycle center enables the user to dispose of the plastic, glass, metal components, printed tube board (PCB), cable, battery, warm-up plate, and motor of the device.
- Send the hardboard package and protective plastic package to the recycle center.

# 2 Installation and Configuration

## 2.1 Device Composition

The CPAP Device consists of host and Power adapter..

## 2.2 Device Description

Figure 2-1 Front of the Device

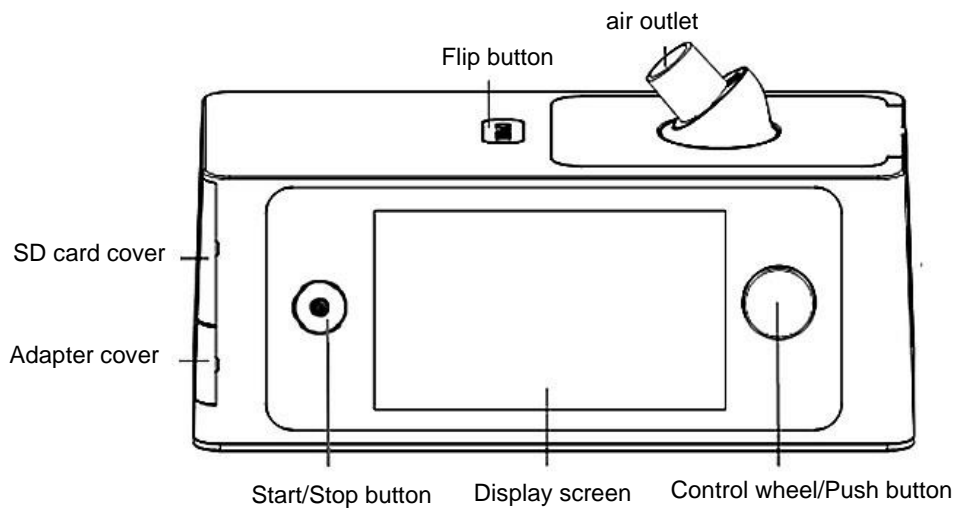

Button/module	Description
Flip button	Use this button to open the top cover of the water tub.
Air outlet	connected to the air tubing.

Button/module	Description
Display screen	<p>Used to select and display menu, treatment information, and alarm information.</p> <p>The display screen supports three operations: click, double click, slide up and down on the screen.</p> <ul style="list-style-type: none"> <li>● Click: when click the parameter on the display screen, the specified parameter is selected; when click the parameter value on the setup screen, the specified value is selected.</li> <li>● Double click: when double click the parameter on the display screen and the parameter value will turn yellow, the specified parameter setup screen is entered.</li> <li>● Slide up and down on the screen: when the finger slide up and down on the setup screen, different values are selected or the value of the specified parameter is increased or decreased.</li> </ul>
Control wheel/push button	<p>Use this button to select a menu option and confirm the selection.</p> <p>The control wheel button/push button supports three operations: pressing (for confirming the selection), rotating clockwise, and rotating counterclockwise.</p> <ul style="list-style-type: none"> <li>● Pressing: when the button is pressed on the parameter setup screen, the specified function is selected.</li> <li>● Rotating clockwise/counterclockwise: When the control wheel is rotated in the menu column, the previous/next menu option is selected. When the control wheel is rotated in parameter options, different values are selected or the value of the specified parameter is increased or decreased.</li> </ul>
Start/Stop button	Use this button to start or stop treatment.
SD card cover	Protect SD card slot and Micro USB interface from dust or physical damage.
Adapter cover	Protect adapter interfaces from dust or physical damage.

**CAUTION**

- The manual describes the quickest way to operate the device. Users can choose other methods of operation according to the function of the device and personal habits.

Figure 2-2 Left Side Interfaces of the Device

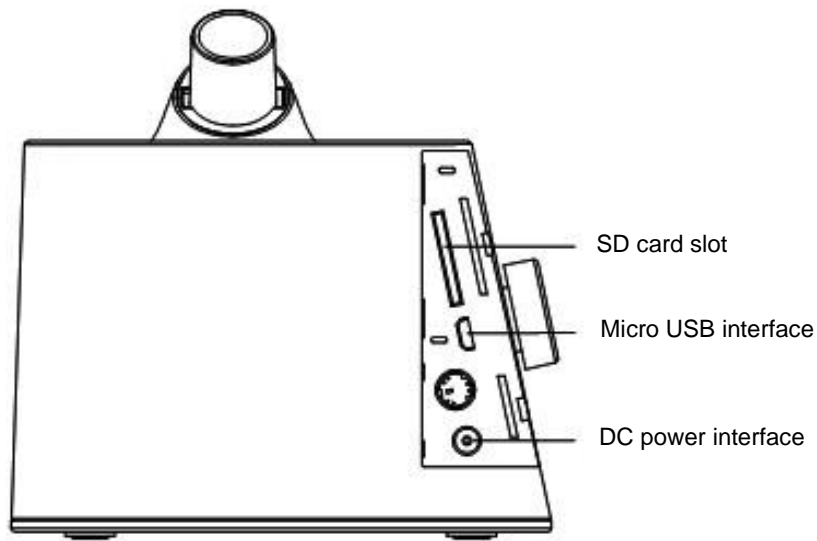

Interface	Description
SD card slot	An SD memory card is pre-installed for storing up to one year of treatment data.
Micro USB interface	Interface for importing information (e.g. serial number) and debugging.
DC power interface	connected to the DC power adapter

Figure 2-3 Back View of the Device

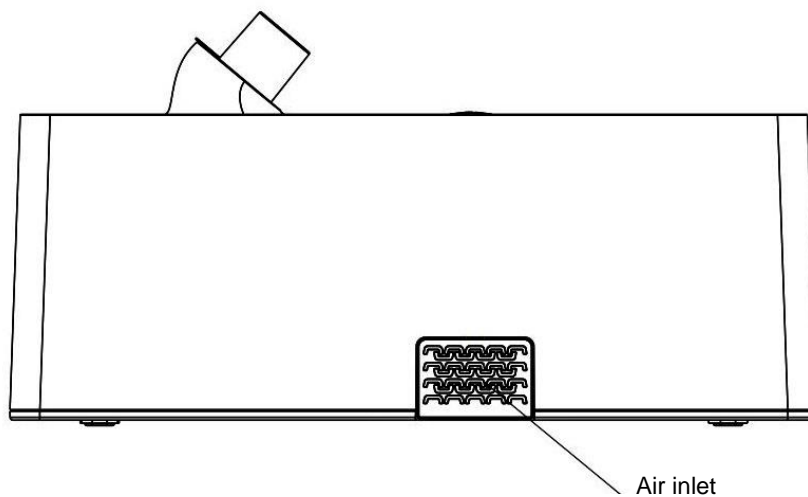

Interface	Description
Air inlet	For installing the air filter.

## 2.3 Installation

Take the following steps to install the CPAP Device:

1. Open the cap of the device by pressing the flip button, and take out the water tub.
2. Pour a proper amount of purified water into the water tub. Be sure not to exceed the highest water level.
3. Put the water tub back in the device and gently press on the cap.

---

**CAUTION**

- Only purified water can be added to the water tub. If running water or mineral water is added, incrustation will occur, affecting the service life of the water tub.

- 
4. Install the air filter.

Gently pinch on both sides in the lower part of the air filter cover, take off the cover, insert the air filter into the cover, insert the upper part of the cover into the pilot hole, and press the lower part of the cover so that the cover is locked.

5. Install the SD card.

- a. Open the SD card cover on the left side of the device and insert the SD card into the memory card slot, with the metal plate on the card facing the front of the device.
- b. When the SD card is properly inserted, the SD card icon at the top right of the screen lights up. Tap the SD card and the SD card will eject from the memory card slot.

6. Connect to the tubing and put on the mask.

- a. Connect one end of the tubing to the air outlet of the device and the other end to the mask with the exhalation port.
- b. Gently fit the mask onto your nose, adjust the mask, and gently tighten the four elastic bands until you have a comfortable fit.

7. Connect to a power supply.

- a. Connect the DC power plug of the power adapter to the DC power interface on the left side of the device and connect the AC power plug to the AC power socket.
- b. The device performs startup initialization and automatic calibration. After startup, the display shows as shown in Figure 2-4.

**Figure 2-4 Startup Screen**





**CAUTION**

- The device enters the power-on standby state after being connected to a power supply.
- The temperatures on both sides of the DC power adapter increase when the ventilator is operating. It is a normal phenomenon.
- Place the ventilator on a firm and flat surface away from any heating or cooling equipment (such as fans, radiators, or air-conditioners). Do not block the vent holes with objects and ensure normal air circulation inside the ventilator.





## 2.4 Home Screen

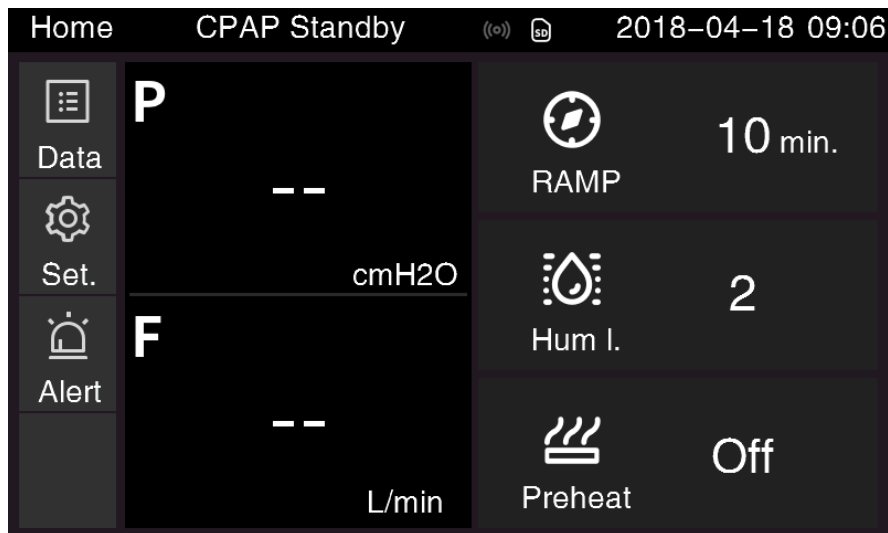







Taking the DM28-20A-WP as an example, when the power connection is successful, and the device is in a normal state, the device will automatically enter the **Home** screen. See Figure 2-5.

Figure 2-5 Home screen



The functions of the icons on the main interface are described in the following table.

No.	Icon	Meaning	NOTE
1		Data	View the data and score of the day.
2		Settings	Setting basic parameters such as Mask Type, Tube, Pressure Units, and Language.
3		Alert	Parts reminder settings, alarm settings, and about the device.
4		WIFI	Connect to the WIFI.  <b>NOTE</b> If the model has no WIFI function, relevant parameters and interface are all hidden.

No.	Icon	Meaning	NOTE
5		Real-time Pressure	Display real-time-pressure.
6		Real-time Flow	Display real-time-flow.
7		Ramp time	Setting the ramp time.
8		Humidity level	Setting the humidity level of the the air in the tubing.
9		Preheating	Setting the preheating of the heated air tubing.
10		Wi-Fi connection	<p>The connection status of the Wireless LAN (Wi-Fi ).</p> <ul style="list-style-type: none"> <li>• Highlighted icon: Wi-Fi is on.</li> <li>• Grey icon: Wi-Fi is off.</li> </ul> <p><b>NOTE</b></p> <p>This icon is only displayed on the DM28-20A-WP models.</p>
11		SD card	<p>The connection status of the SD card.</p> <ul style="list-style-type: none"> <li>• Highlighted icon: SD card is inserted.</li> <li>• Grey icon: SD card is not inserted.</li> </ul>
12		Data time	The current data time of the device.

# 3 Parameter Settings

## CAUTION

- The humidity level and ramp time can be set by the patient, other parameters must be set by a licensed physician or under the instruction of a licensed physician.

## 3.1 Ramp Time

You can set ramp on the home screen to increase the treatment comfort degree (The ramp feature is disabled by default).

1. Double click  on the **Home** screen to enter the **RAMP** screen.
2. Rotate the control wheel to select the ramp time and press the control wheel to confirm the selection.

When the ramp feature is enabled, the ventilator outputs an initial pressure and slowly increases the initial pressure to the therapeutic pressure during the predefined ramp time to help the patient fall asleep. When the ramp time ends, the ventilator automatically detects the patient's respiration conditions and adjusts pressure accordingly.

## 3.2 Humidity Level

You can set the humidity level for the warm-up of the humidifier to ensure that the air output by the ventilator has a proper temperature when being humidified.

### 3.2.1 Setting the Humidity Level

1. Double click  on the **Home** screen to enter the **Humidity Level** screen.
2. Rotate the control wheel to select a humidity level for the humidifier and press the control wheel to confirm the selection.

The level of humidity can be set before or after treatment. The value of Humidity Level ranges from **1** to **6**, or it can be set to **Off**.

- The temperature level gear corresponds to the temperature range of the heating base plate and the time from the initial temperature ( $23^{\circ}\text{C} \pm 2^{\circ}\text{C}$ ) to the corresponding level gear is as follows. 1st gear: temperature range  $23^{\circ}\text{C} \pm 5^{\circ}\text{C}$ , it take 0 minute to reach the temperature from the initial temperature( $23^{\circ}\text{C} \pm 2^{\circ}\text{C}$ ).
- 2st gear: temperature range  $30^{\circ}\text{C} \pm 7^{\circ}\text{C}$ , it take (25~35) minute to reach the temperature from the initial temperature( $23^{\circ}\text{C} \pm 2^{\circ}\text{C}$ ).

- 3st gear: temperature range  $38^{\circ}\text{C} \pm 10^{\circ}\text{C}$ , it take (25~35) minute to reach the temperature from the initial temperature( $23^{\circ}\text{C} \pm 2^{\circ}\text{C}$ ).
- 4st gear: temperature range  $43^{\circ}\text{C} \pm 10^{\circ}\text{C}$ , it take (25~35) minute to reach the temperature from the initial temperature( $23^{\circ}\text{C} \pm 2^{\circ}\text{C}$ ).
- 5st gear: temperature range  $48^{\circ}\text{C} \pm 10^{\circ}\text{C}$ , it take (25~35) minute to reach the temperature from the initial temperature( $23^{\circ}\text{C} \pm 2^{\circ}\text{C}$ ).
- 6st gear: temperature range  $53^{\circ}\text{C} \pm 10^{\circ}\text{C}$ , it take (25~35) minute to reach the temperature from the initial temperature ( $23^{\circ}\text{C} \pm 2^{\circ}\text{C}$ ).

### 3.2.2 Stop warming or cooling.

Rotate the control wheel to **Off**, and press the control wheel to stop warming or cooling.

---

**CAUTION**

- Humidity level is set to a proper value if small drops of condensed water exist inside the groove of the tubing in the next morning. Humidity Level is set to an excessively large value if many water droplets exist inside the tubing and mask; humidity level is set to an excessively low value if you feel nose dryness; in these cases, reduce or increase the value of humidity level.
  - When you lie down, keep the ventilator slightly lower than your head so that drops of condensed water flow back to the water tub of the humidifier to prevent respiratory impairment.
  - Empty water in the water tub when it is not used.
- 

## 3.3 Preheating

You can set preheating on the home screen.

1. Select **Preheat**  on the **Home** page
2. Press and hold the control wheel to select the preheating state to complete the setting.

---

**CAUTION**

- The Preheating can only be turned on when the humidity level is not off. If the preheating is not performed, the device will start warming and humidifying based on the humidity level automatically during treatment.
  - Preheating temperature is consistent with humidity level gear temperature.
- 

## 3.4 User Setup

You can set the parameters such as Mask Type, Tube, Pressure Units, and Language..

1. Click **Set.**  on the **Home** screen to enter the user setup interface. see Figure 3-1.

Figure 3-1 User setup



2. Select the parameters as required.

The operation methods are as follows:

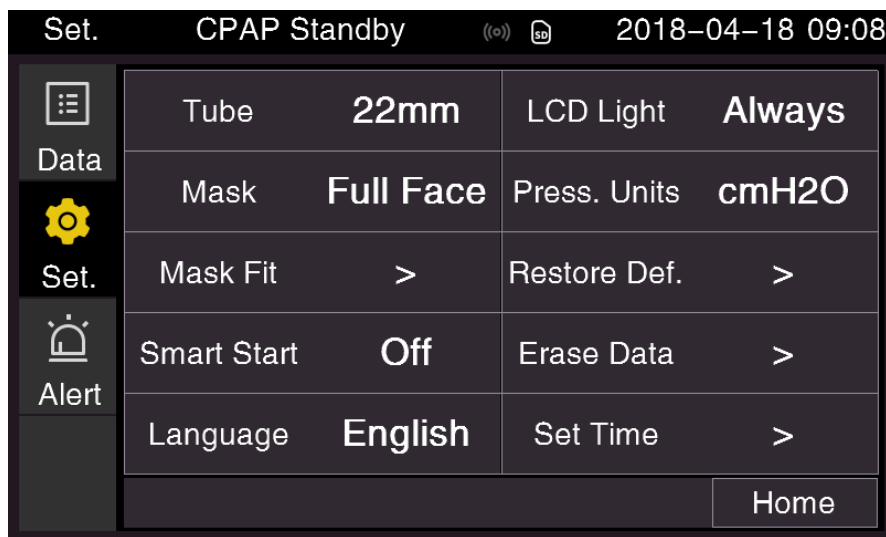
- Rotate the control wheel clockwise or counterclockwise to switch to other menus or options. Press the control wheel to confirm the settings.
- Double click **Home** to return the home screen.

The patient can set the parameters by referring to the table below.

Parameter	Meaning	Setting Description
Tube	The type of the air tubing. A standard tube with a diameter of 22mm and a length of 1.8m~2.0m is used by default.	Values: 22mm, 15mm. The default value is <b>22mm</b> .
Mask	The type of the mask. <b>NOTE</b> The <b>Mask</b> parameter appears on the user setup screen only when the <b>Mask</b> parameter on the detailed setup screen is set to <b>Patient</b> .	Values: Nasal, Full Face, Pillow. The default value is <b>Full Face</b> .
Mask Fit	Check whether the mask is properly connected with no leaks. If the patient does not stop the mask fit function halfway, the ventilator will automatically start treatment 3 minutes after the mask is put on. <ul style="list-style-type: none"> <li>• When the mask does not have air leaks, a prompt is displayed indicating that the mask is worn properly.</li> <li>• When the mask has air leaks, a prompt is displayed indicating that the mask needs to be adjusted.</li> </ul>	Press the control wheel to start the mask fit function; press the control wheel again to stop the mask fit function.

Parameter	Meaning	Setting Description
Smart Start	When the device is in standby state and the patient puts on the mask and takes deep breathing 2~3 times, the device will start automatically and output the predefined pressure. After the mask is taken off, the treatment will stop.	Values: On, Off. The default value is <b>Off</b> .
Language	This parameter specifies the language used by the device.	Values: English, Chinese. The default language is <b>English</b> .
LCD Light	This parameter is used to enable or disable the screen backlight. <ul style="list-style-type: none"> <li>• Auto: The backlight is turned off some time after no button is pressed and is turned on when a button is pressed.</li> <li>• Always (normal mode): The backlight is always on and the display brightness is normal.</li> </ul>	Values: Auto, Always. The default value is <b>Always</b> .
Press. Units	This parameter is used to set the pressure units of the ventilator.	Values: hPa, cmH <sub>2</sub> O The default value is <b>cmH<sub>2</sub>O</b> .
Restore Def.	This parameter is used to restore the ventilator to factory defaults.	Values: Yes, No. The default value is <b>No</b> .
Erase Data	This parameter is used to delete the patient's sleep quality and sleep report data.  <b>NOTE</b> When the device is inserted into the memory card, all data on the memory card will be erased. Please be cautious.	Values: Yes, No. The default value is <b>No</b> .
Set Time	This parameter specifies the current date and time of the device. It is in the format of YYYY-MM-DD hh-mm, for example, 2014-01-01 12:30.	<ul style="list-style-type: none"> <li>• YYYY: specifies the year, for example, 2014.</li> <li>• MM: specifies the month, such as 01.</li> <li>• DD: specifies the date, such as 01.</li> <li>• hh: specifies the hours, such as 12.</li> <li>• mm: specifies the minutes, such as 30.</li> </ul> <b>NOTE</b> During operation, the device records the user's usage information based on this clock. Therefore, it is necessary to check the option frequently to make sure the clock accuracy .

## 3.5 Advanced Setup

**CAUTION**

- The parameters on the advanced setup screen must be set by a licensed physician or under the instruction of a licensed physician.

Click **Set.**  menu on the **Home** screen and press the control wheel for 3s to enter the advanced setup screen (see Figure 3-2). You can select the corresponding treatment mode in the advanced setup interface, for detailed descriptions of the treatment settings, see section **1.2 Product Description**.

Double click to set the parameter. Rotate the control wheel clockwise or counterclockwise on the advanced setup screen to switch to other menus or options. Press the control wheel to confirm the settings. Double click **Home** to return the home screen.

Figure 3-2 Advanced Setup

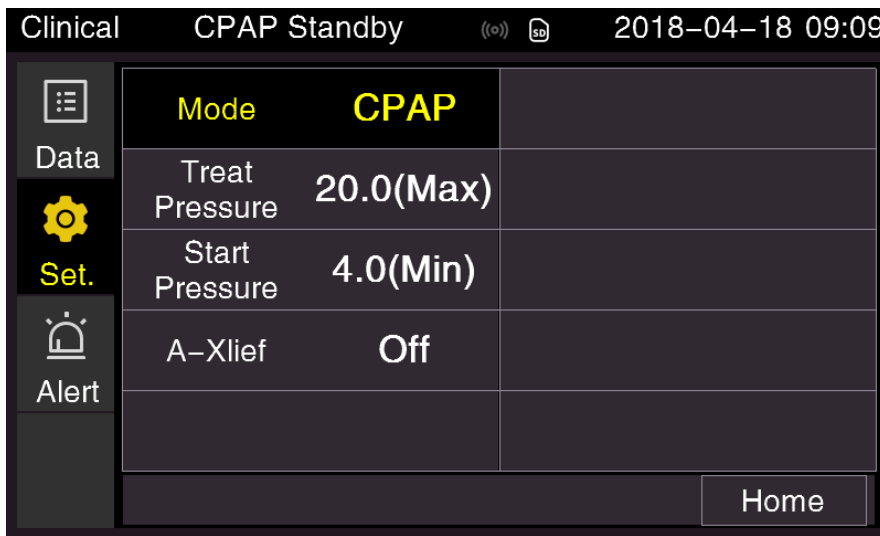

**CAUTION**

- The modes and parameters are displayed according to the actual model. Please refer to the actual interface.

### CPAP Mode

Refer to the table below for the detailed instructions of parameter setting.

Parameter	Meaning	Setting Description
Treat Pressure	<p>This parameter specifies the maximum therapeutic pressure in CPAP mode.</p> <p><b>NOTE</b> The parameter is only displayed in <b>CPAP</b> mode.</p>	<p>Value range: 4.0~20.0 The default value is <b>4.0</b></p> <p><b>NOTE</b> The <b>Treat Pressure</b> is not less than the <b>Start Pressure</b>.</p>

Parameter	Meaning	Setting Description
Start Pressure	This parameter specifies the initial pressure output by the ventilator when the ramp feature is enabled.	Value range: 4.0~20.0 The default value is <b>4.0</b> . <b>NOTE</b> The <b>Start Pressure</b> is not greater than the <b>Treat Pressure</b> . If the <b>Treat Pressure</b> is 10.0, the setting range of the <b>Start Pressure</b> is 4.0~10.0.
A-Xlief	The ventilator automatically detects respiratory rhythm when it is operating and reduces the pressure inside the mask during exhalation to increase the patient comfort level.	Values: 1, 2, 3, Off. The default value is <b>Off</b> . The higher the value, the higher the pressure release level.

## APAP Mode

Refer to the table below for the detailed instructions of parameter settings in APAP mode.

Parameter	Meaning	Setting Description
Max Pressure	This parameter specifies the maximum value of the output pressure. <b>NOTE</b> The parameter is only displayed in <b>APAP</b> mode.	Value range: 4~20.0 The default value is <b>20.0</b> . <b>NOTE</b> The <b>Max Pressure</b> is not less than the <b>Min Pressure</b> . If the <b>Min Pressure</b> is 10.0, the setting range of the <b>Max Pressure</b> is 10.0~20.0.
Min Pressure	This parameter specifies the minimum value of the output pressure. <b>NOTE</b> The parameter is only displayed in <b>APAP</b> mode.	Value range: 4.0~20.0 The default value is <b>4.0</b> . <b>NOTE</b> The <b>Min Pressure</b> is not greater than the <b>Max Pressure</b> . The <b>Min Pressure</b> is not less than the <b>Start Pressure</b> . If the <b>Start Pressure</b> is 5.0 and the <b>Start Pressure</b> is 10.0, the setting range of the <b>Min Pressure</b> is 5.0~10.0.
Start Pressure	This parameter specifies the initial pressure output by the ventilator when the ramp feature is enabled.	Value range: 4.0~20.0 The default value is <b>4.0</b> . <b>NOTE</b> The <b>Start Pressure</b> is not greater than the <b>Min Pressure</b> . If the <b>Min Pressure</b> is 5.0, the setting range of the <b>Start Pressure</b> is 4.0~5.0.



Parameter	Meaning	Setting Description
A-Xlief	The device automatically detects respiratory rhythm when it is operating and reduces the pressure inside the mask during exhalation to increase the patient comfort level.	Values: 3, 2, 1, Off. The default value is <b>Off</b> . The higher the value, the higher the pressure release level.

## 3.6 Alert

### 3.6.1 Parts Reminder

Click **Alert**  on the screen and click **Parts** to setup parameter. On the parts reminder interface( See Figure 3-3). you can set a time to remind the patient to replace the component or perform device maintenance.

Figure 3-3 Parts Reminder



Parameter	Setting Description
Tube	This parameter specifies the time for notifying the user of contacting his/her device supplier to replace the air tubing. The default value is <b>Off</b> , indicating that the user is not notified..  <b>NOTE</b> The shelf life of air tubing is 3 years. It is suggested to change the air tubing after every one year use.
Water Tub	This parameter specifies the time for notifying the user of contacting his/her device supplier to replace the water tub. The default value is <b>Off</b> , indicating that the user is not notified.

Mask	<p>This parameter specifies the time for notifying the user of contacting his/her device supplier to replace the mask. The default value is <b>Off</b>, indicating that the user is not notified..</p> <p><b>NOTE</b> The shelf life of mask is 24 months. It is suggested to change the mask after every 6 months use.</p>
Filter	<p>This parameter specifies the time for notifying the user of contacting his/her device supplier to replace the filter. The default value is <b>Off</b>, indicating that the user is not notified..</p> <p><b>NOTE</b> The air filter of the device is not washable. It is suggested to be changed after 3~6 months use. Please contact your local agent for purchasing.</p>
Service	<p>This parameter specifies the time for notifying the user of sending the ventilator to his/her device supplier for maintenance. The default value is <b>Off</b>, indicating that the user is not notified.</p>
Back	<p>Select <b>Back</b> and press the control wheel to return to the previous page.</p>

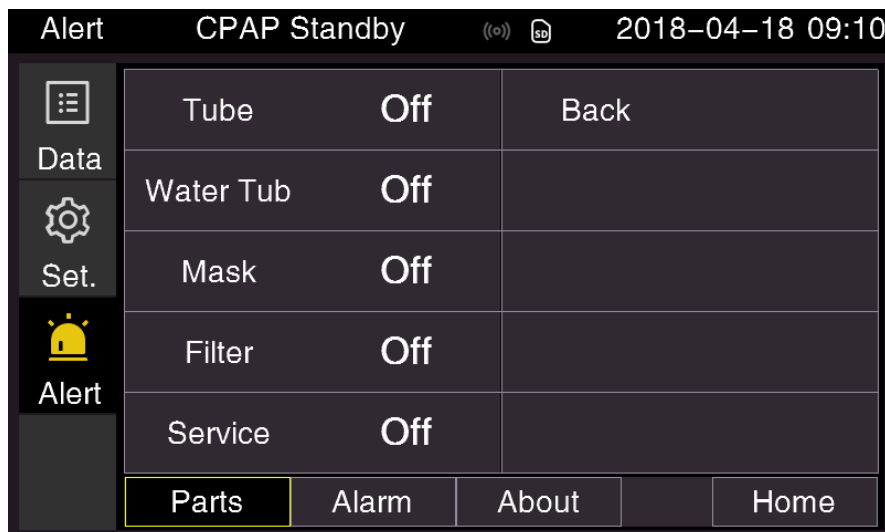
### 3.6.2 Alarm Settings

Click **Alert**  on the screen and click **Alarm** to setup parameter. See Figure 3-4.

Figure 3-4 Alarm Settings

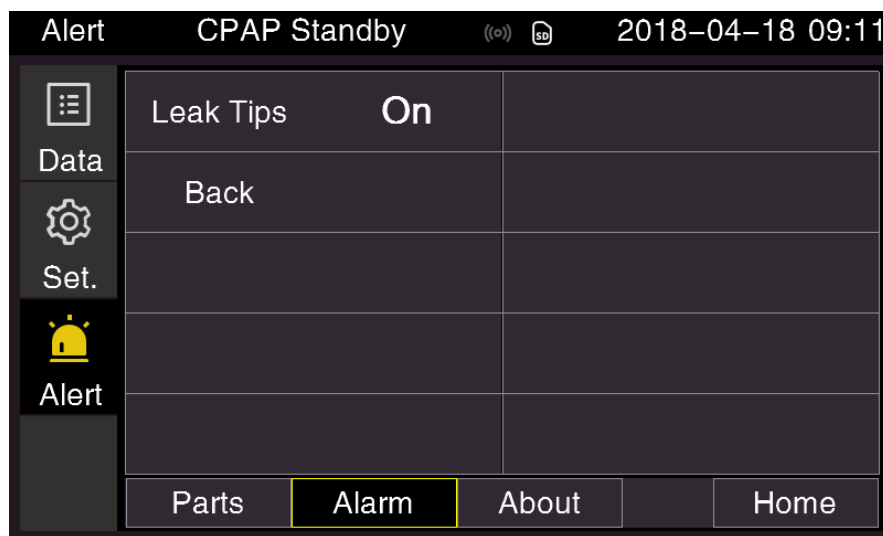

Parameter	Setting Description
Leak Tips	<p>In the normal working process, a large amount of air leakage is caused by mask falling off or other reasons. The user can set whether the interface pops up a prompt.</p> <p>On: The corresponding prompt pops up on the screen. Off: No prompt.</p>
Back	<p>Select <b>Back</b> and press the control wheel to return to the previous page.</p>

### 3.6.3 About The Device

Click **Alert**  on the screen and click **About** to view native information. You can view the current model, serial number, version number and running time of the device, see Figure 3-5.

Figure 3-5 About The Device



# 4 Routine Use

---

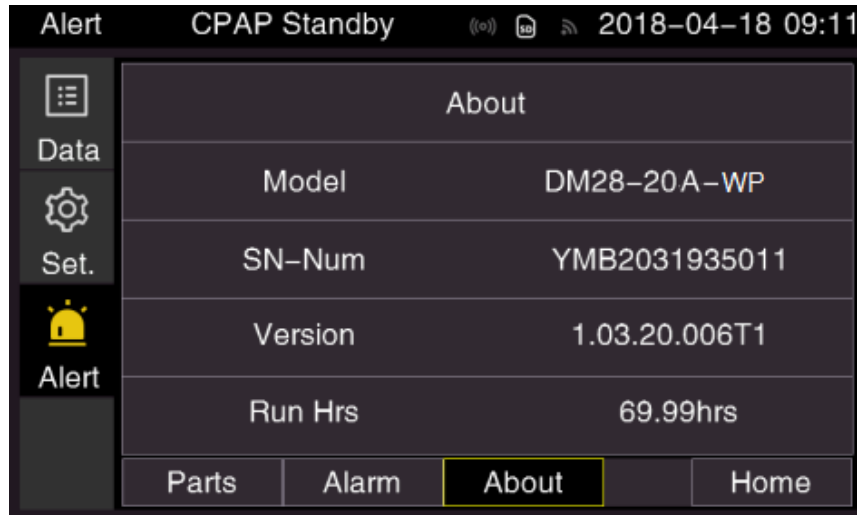
The patient can undergo treatment by using the methods described in this chapter, or view the sleep quality and sleep report the previous day and the device information.

## 4.1 Treatment Steps

---



### WARNING

- Do not perform repair or maintenance when the device is operating.
- 
- 

### CAUTION

- Check whether the tube is damaged or contains foreign bodies each time before using the ventilator. If the tube is damaged or contains foreign bodies, clean or replace the tube.
  - The ventilator can be used only after completion of treatment parameter settings (including detailed treatment settings, ramp settings, and humidity level settings) by a licensed physician or under the instruction of a licensed physician.
- 

1. Connect the device based on section **2.3 Installation**
2. Lie down on a bed and adjust the tube so that the tube can move freely when you turn over during sleep.
3. Put on the mask and tie the headbands and adjust them until you have a comfortable fit and there are no air leaks when you breathe.
4. Press the Start/Stop button to start treatment.

If the Smart Start function is enabled, you can take two deep breaths and the device will automatically start treatment. See **3.4 User Setup**.

5. Adjusting the humidity level will help to make breathing more comfortable.  
For details, see **3.2 Humidity Level**.
6. After the treatment, press the Start/Stop button to stop therapy.  
After the treatment is stopped, the device stops warming and begins to cool. Cooling is complete after approximately 30 minutes.
7. After using the ventilator, put off the mask and headbands and unplug the power cord to shut down the ventilator.

**CAUTION**

- In the case of power failure or in the unlikely event of fault conditions, take off the mask to avoid inhaling the air you have exhaled previously.
- In the case of power failure, the device will shut down automatically. After power restoration, the device will automatically start up and return to the initial interface (Figure 2-4).
- Do not block the air inlet and outlet of the ventilator with any bed cover, curtain, or other objects.
- The air tubing should not be covered by bed cover or affected by heating source (such as electric blankets), otherwise it may lead to tubing deformation and danger.
- Always keep the air outlet of the humidifier lower than the tube and mask to prevent ingress of water inside the tube.

## 4.2 Viewing Data

Click **Data**  menu on the Home screen to enter the **Data** interface.

- You can view the data and score of the day.
- You can select Wi-Fi transmission to store treatment data to the cloud platform.
- For a ventilator with QR code feature , you can scan the QR code on the mobile phone to view the last treatment evaluation result on the mobile phone side, and adjust the treatment operation according to the evaluation result.

### 4.2.1 Day Data

You can view the device usage in a period of time through the Data, see Figure 4-1.

Figure 4-1 Day Data

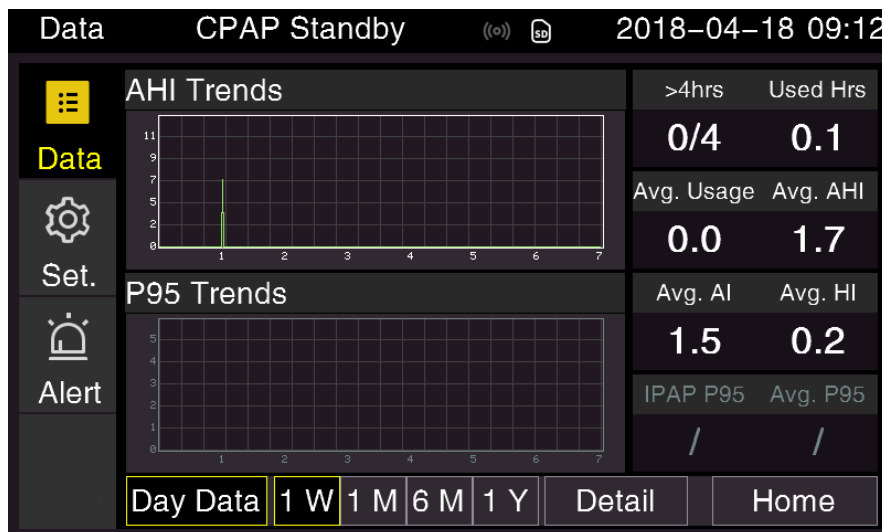

Parameter	Description
Period	This parameter specifies the period of a sleep report, which may be one day, one week, one month, three months, six months, or one year.

Days>4hrs	This parameter records the number of days when the ventilator is used for more than 4 hours.
Used Hrs	This parameter records the total hours of device usage.
Avg. Usage	This parameter records the average hours of device usage every day.
Avg. AHI	This parameter records the average AHI (the sum of sleep apnea and hypoventilation per hour) during the user's sleep report period.  <b>NOTE</b> The Avg. AHI is equal to the number of "apneas + hypopneas" obtained during the sleep report period divided by the time of usage.
Avg. AI	This parameter records the average AI (mean apnea index) during the user's sleep report period.
Avg. HI	This parameter records the average AI (average low flux index) during the user's sleep report period.
IPAP P95	This parameter records the IPAP P95 during the user's sleep report period.  <b>NOTE</b> IPAP P95 is the sum of P95 during the sleep report period divided by the number of days that are used for more than 4 hours.
Avg. P95	This parameter records the average P95 during the user's sleep report period.  <b>NOTE</b> Avg. P95 is the sum of P95 during the sleep report period divided by the number of days that are used for more than 4 hours.

## 4.2.2 Detail

The Detail interface see Figure 4-2, Display the QR code of the day's treatment, and the detailed data of the day's treatment will be displayed after scanning.

Figure 4-2 Detail

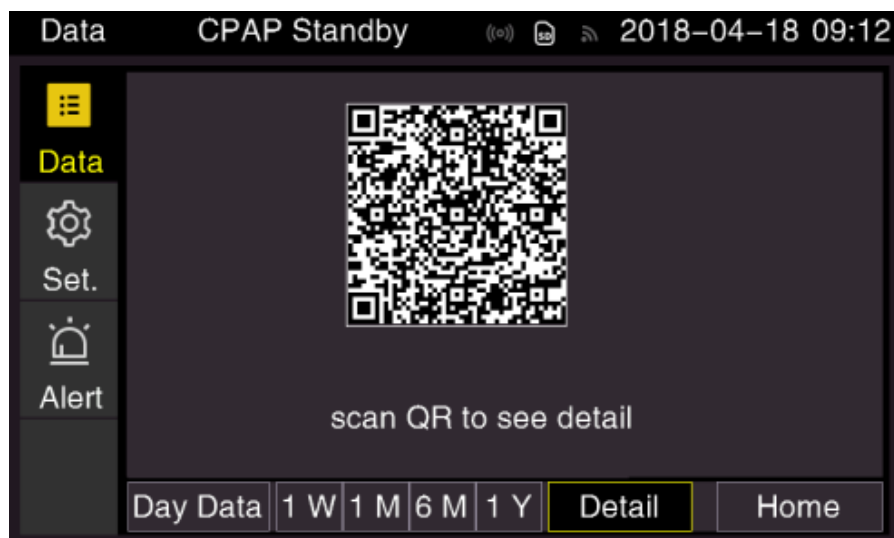

## 4.3 Alarm

If there is a malfunction or improper use during the use of the device, the device will give an alarm tone or an interface prompt according to user Settings.

The user can set whether the Leak Tips prompt interface pops up a prompt box, see 3.6.2 Alarm Settings

Alarm Name	Definition
Power failure alarm	Power interruption during treatment <b>NOTE</b> This feature is turned on by default and is not editable by the user.
Temperature alarm	Humidifier temperature is too high (75 °C) <b>NOTE</b> This feature is turned on by default and is not editable by the user.
High pressure alarm	When starting treatment, if the fan speed is high but there is no pressure output, when the actual output pressure is higher than 35hpa, the high pressure alarm will pop up and the treatment will be stopped automatically. Press the control wheel to clear the prompt. <b>NOTE</b> This feature is turned on by default and is not editable by the user.
High leakage alarm	During the treatment, if the humidifier cover is opened for 3 seconds, a prompt box pops up. please check the system and press the control wheel to clear the prompt. <b>NOTE</b> This feature is turned on by default and is not editable by the user.
Air leak alarm	When the mask leaks: <ul style="list-style-type: none"> <li>• If the <b>Smart Start</b> is <b>On</b>, the device turns off the treatment.</li> <li>• If the <b>Smart Start</b> is <b>Off</b>, the device pops up a prompt box, which can be closed by pressing the control wheel.</li> </ul>

# 5 Cleaning and Maintenance

---



## WARNING

- Unplug the device before cleaning.
  - Clean the mask and air tubing based on the instruction of the manufacturer and determine the cleaning period.
  - Do not perform repair or maintenance when the device is operating.
- 
- 

## CAUTION

- Do not clean the device and accessories with any abrasive cleaner, alcohol, chlorine-bearing compound, acetone, or any other solvents.
  - Over-warming of materials may cause material pre-aging.
  - Wash all accessories and parts of the humidifier in clean water after cleaning with a detergent. Wipe all parts with a lintless cloth to prevent calcareous sediments accumulation.
- 
- 

The device and accessories must be cleaned regularly under normal usage to prevent the user from contracting respiratory tract infection.

## 5.1 Daily Cleaning

The mask, water tub of the device must be cleaned daily.

---



## WARNING

- Ensure that the ventilator is unplugged and the water tub of the humidifier is cool before cleaning.
- 

### Mask

Carefully clean the mask with a mild detergent.

- Carefully clean the silica gel pad that is in close contact with skin during normal usage.
- Check whether the vent holes of the mask are unblocked.
- Rinse the mask in clean water and wipe the mask with a clean cloth to prevent stains.
- Suspend and air dry the mask. Avoid direct sunlight on the mask or place the mask on a radiator.



**CAUTION**

- It is suggested to change the mask after every 6 months use.
- 

### Water Tub

**CAUTION**

- Prevent ingress of water inside the ventilator during washing.
- 

It is recommended that water in the water tub be changed and the water tub be washed every day based on the following steps:

1. Unplug the ventilator and allow approximately 15 minutes for the humidifier to cool down.
2. Open the cap of the device by pressing the flip switch. Take out the water tub and discard any remaining water.
3. Wash all parts in the dishwasher or a solution of warm water (not higher than 50oC) and a mild dishwashing detergent.
4. Rinse the water tub with clean water and allow to air dry.
5. Put the water tub back into the device and close the top cover.
6. Inspect the water tub for any leak or damage. Replace the water chamber if any damage is present.

## 5.2 Weekly Cleaning

### Air Filter

The air filter of the device is not washable. It is suggested to be changed after 3–6 months use. Please contact your local agent for purchasing.

---

**CAUTION**

- The standby air filters should avoid direct sunlight, be away from wet or cold site, otherwise they will be damaged.
- 

### Enclosure

Wipe the outside of the device with a cloth slightly dampened with water. Use a dishwashing detergent when necessary.

---

**CAUTION**

- Before using the ventilator, ensure that the enclosure is thoroughly dry and there are no moisture ingress inside the ventilator.
-

## Air Tubing

---

**CAUTION**

- It is suggested to change the air tubing after every one year use.
- 
1. Disconnect the tube from the ventilator and mask.
  2. Clean the tube with a detergent and rinse the tube in clean water.
  3. Air dry the tube in a shady and cool place until the tube is thoroughly dry.

## Cleaning the Headbands

---

**CAUTION**

- Do not iron the headbands; otherwise, the magic tapes of the bands may be damaged.
- 
1. Remove the headbands from the mask.
  2. Wash the bands by hand in water at about 30°C or in a solution of warm water containing mild soap liquids. (Because the headbands may be decolored, wash the bands separately for the first time.)
  3. Spin-dry the headbands at low speeds or drain the headbands.

## 5.3 Disinfection

### 5.3.1 Disinfecting the Device

Generally there is unnecessary to sterilize the device if you follow the right cleaning instructions. When the humidifier was contaminated or used in clinical, you can get standard disinfectants from a pharmacist to do the disinfection.

---

**CAUTION**

- Disinfectants will damage the device's surface and shorten its life. Therefore, for the specific disinfectant suitable materials and instructions, you should follow the manufacturer's advise.
- After cleaning with disinfectants, wash all parts of the device in close with the patient in clean water, such as the mask, headbands and tube, to keep skin away from infections.

---

After disinfection, check if there are any parts damaged traces. If so, please replace the defective parts.

## 5.4 Transfer the Device

When the device is transferred to another patient, for health reason, it is recommended that you replace the parts in contact with the patient, such as the mask, headbands, water tub, tub and air filter.

After the transfer, the device can be used only after completion of treatment parameter settings under the instruction of a licensed physician.

# 6 Service and Repair

---

---

**CAUTION**

- The CPAP Device should be maintained by the user.

---

Check the following items before using the ventilator:

- Check whether the air tubing and mask are sealed.
- Check whether the treatment pressure is generated and appears on the display screen.
- Check whether the water inside the water tub is warmed up.

If the device is faulty, or unexpected operation or events occur, contact Yamind or your device supplier. CPAP Device Repair can only be done by an authorized engineer.

Long-term usage and free repair service of the CPAP Device are possible only when the user complies with the security and cleaning & maintenance guidelines.

# 7 Troubleshooting

The table below lists common problems you may have with the device and possible solutions to those problems. If none of the corrective actions solve the problem, contact your physician or device supplier.

Problem	Possible Cause	Solution
You feel mucosa drying in nasal cavity, nose coldness or congestion, have a running nose, or catch a cold.	The symptoms are the nose's responses to the airflow from the ventilator or cold symptoms. Nose coldness is caused by the fast-flowing air, stimulating the nasal mucosa and resulting in nose dryness or swelling.	<ul style="list-style-type: none"> <li>• Increase the humidity level.</li> <li>• Consult your physician. Do not stop treatment unless advised by your doctor.</li> </ul>
You feel dryness in the oral cavity or throat.	You may sleep with your mouth open.	<ul style="list-style-type: none"> <li>• Wrap a fixing band around your lower jaw.</li> <li>• Consult your physician and consider the use of a full-face mask.</li> </ul>
OSA occurs multiple times during a day.		
You have pricking eyes.	<ul style="list-style-type: none"> <li>• The mask is not fixed properly, causing air leaks.</li> <li>• The size and model of the mask are incorrect.</li> </ul>	<ul style="list-style-type: none"> <li>• Shorten the distance between the prefrontal frame of the mask and your forehead.</li> <li>• Contact your device supplier and select a mask of a different model. Insert fillers into the mask when necessary.</li> </ul>
The skin in the contact position between your face and the mask reddens.	<ul style="list-style-type: none"> <li>• The mask pad (the soft part inside the mask) hardens.</li> <li>• The mask is too tight.</li> <li>• The distance between the prefrontal frame of the mask and your forehead is incorrect.</li> <li>• The size of the mask is incorrect.</li> <li>• You are allergic to the mask materials.</li> </ul>	<ul style="list-style-type: none"> <li>• Replace the mask or mask pad.</li> <li>• Loosen the mask and headbands.</li> <li>• Try different distances.</li> <li>• Contact your device supplier and select a different mask.</li> <li>• Use a fixing material in the contact position between your face and the mask and consult your physician and device supplier, or use a rubber-free mask. Ingress of water inside the mask.</li> </ul>

Problem	Possible Cause	Solution
Ingress of water inside the mask.	The temperature difference between the air tubing and surrounding air causes condensation.	<ul style="list-style-type: none"> <li>• Reduce the temperature level of the device or increase the temperature of the surrounding environment.</li> <li>• Always keep the air outlet of the device lower than the tube and mask to prevent ingress of water inside the tube.</li> </ul>
You feel pain in the nose, paranasal sinuses, or eyes.	Nasosinusitis or otitis media	Contact your physician immediately.
You feel uncomfortable because the treatment pressure is not suitable.	The user will feel uncomfortable when the treatment pressure is higher than 13 hPa. In some situations, however, it is necessary to set the treatment pressure over 13 hPa to prevent OSA.	It may take up to four weeks to adapt to the treatment pressure. Try to relax yourself when using the ventilator. Breathe through your nose and keep your mouth closed. If the problem persists, contact your physician.
The noise level is too high.	<ul style="list-style-type: none"> <li>• The air tubing is connected incorrectly.</li> <li>• The water tub is not well connected to the host..</li> </ul>	<ul style="list-style-type: none"> <li>• Connect the air tubing to the correct interface of the host.</li> <li>• Reconnect the water tub to the host.</li> </ul>
The inhaled air is too hot.	<ul style="list-style-type: none"> <li>• The air inlet or air filter is blocked.</li> <li>• The ventilator is too close to a wall, curtain, or other objects, obstructing air circulation.</li> </ul>	<ul style="list-style-type: none"> <li>• Clean or replace the air filter (see section 5.2 Weekly Cleaning) and clean the air inlet.</li> <li>• Place the ventilator in a place with good air flow and in a distance of at least 20 cm away from a wall, curtain, or other objects.</li> </ul>

# Appendix A Specifications

## A.1 Basic Specification

Environment Conditions	-	Operating Environment	Transportation or storage Environment
	Ambient temperature	5°C ~ 35°C	-20°C ~ 55°C
	Relative humidity	15% ~ 95% (non-condensing)	15% ~ 95% (non-condensing)
	Atmospheric pressure	86kPa ~ 106kPa	50kPa ~ 106kPa
Dimensions	272 mm × 143mm × 139.3 mm, Weight 1.6 kg		
AC Input	100~240V AC, 50/60Hz, 72W.		
Power Adapter Output	24V DC, 3.0A		
Running Mode	Continuous running		
Degree of Protection Against Electric Shock	Class II, type BF applied part		
Ingress Protection	IP21		
Safety Level	This device is not AP/APG equipment and not suitable for use in the presence of a flammable anesthetic mixture with air, or with oxygen, or nitrous oxide		
Maximum Gas Temperature	No more than 41°C		
Water Capacity	280mL~320mL (don't exceed the maximum water level)		
Output Humidity	The maximum humidity output is not less than 10 mgH <sub>2</sub> O/L under the conditions of an ambient temperature of 5°C to 35°C and a relative humidity of 15%.		

<b>Mode</b>	<ul style="list-style-type: none"> <li>DM28-20C-G: CPAP</li> <li>DM28-20A-W/DM28-20A-WP: CPAP, APAP</li> </ul>
<b>Sound Pressure Level</b>	≤ 30 dB, when the ventilator is working at the pressure of 10 hPa.
<b>Altitude Compensation</b>	Automatic altitude compensation
<b>Pressure compensation</b>	Automatic air-leak pressure compensation
<b>Air outlet</b>	22 mm conical air outlet
<b>Data storage</b>	Stored in SD card in .edf data format, data management software, Wi-Fi cloud transmission
<b>Transfer Protocol</b>	Wi-Fi module comes with TCP protocol for data transmission
<b>Hardware Configuration</b>	CPU: ARM Cortex series, SDRAM+Flash
<b>Software Environment</b>	Embedded small operating system.
<b>Expected Service Life</b>	5 years

**CAUTION**

- In the extreme conditions of use of the AC power supply voltage -15% ~ +10%, DC power supply voltage -15% ~ +25%, temperature 35 °C ~ 40 °C, relative humidity 10% ~ 15% or atmospheric pressure 70kPa ~ 86kPa Under the device, the device should not malfunction or pose a danger to the user. However, prolonged or repeated operation of device under such extreme conditions may result in premature component aging and require more frequent maintenance.
- At the end of the service life, the device effect may be degraded. Please replace the new device in time.

## A.2 Technical Specification

### Pressure in CPAP and APAP Modes

Pressure Range (hPa)	Interval	Pressure Accuracy	Static Pressure Stability
4.0~20.0	0.2 hpa	No more than ±0.5hPa	The error range does not exceed ±0.5 hPa

### Maximum Single Fault Steady Pressure

CPAP and APAP modes: the pressure between the patient and the tubing is no more than 30hPa under single failure state.

**Pressure Display Accuracy**

± (2% full scale + 4% actual reading)

**Liquid Leakage**

Under normal condition and any single fault condition the volume of liquid exiting the humidification chamber does not exceed: <1ml in 1 minute.

**The gas leakage at the maximum operating pressure**

The gas leakage of the humidification system or individual components as appropriate at the maximum operating pressure: <1l/min.

**Ramp**

The range of the **Ramp Time** is 0~60 minutes, interval is 10 minutes, and the error does not exceed ± 5%.

**Maximum Flow at Set Pressures**

When the pressure is  $P_{min}$ ,  $P_{min}+1/4(P_{max}-P_{min})$ ,  $P_{min}+1/2(P_{max}-P_{min})$ ,  $P_{min}+3/4(P_{max}-P_{min})$  and  $P_{max}$ , the average flow from the patient connection port should be greater than 80% of the corresponding flow value in the table below.

Model	Pressure (hPa)	Patient Connection Port (hPa)	Flow (L/Min)
DM28-20C-G	4.0	3.0	60.0
DM28-20A-W	9.4	8.4	60.0
DM28-20A-WP	14.6	13.6	60.0
	20.0	19.0	60.0

**CAUTION**

- The above values are measured at the end of the airway.
- CPAP:  $P_{max}$  is the maximum treat pressure,  $P_{min}$  is the minimum treat pressure.
- APAP:  $P_{max}$  is the maximum pressure,  $P_{min}$  is the minimum pressure.



### Pressure Capacity Curve

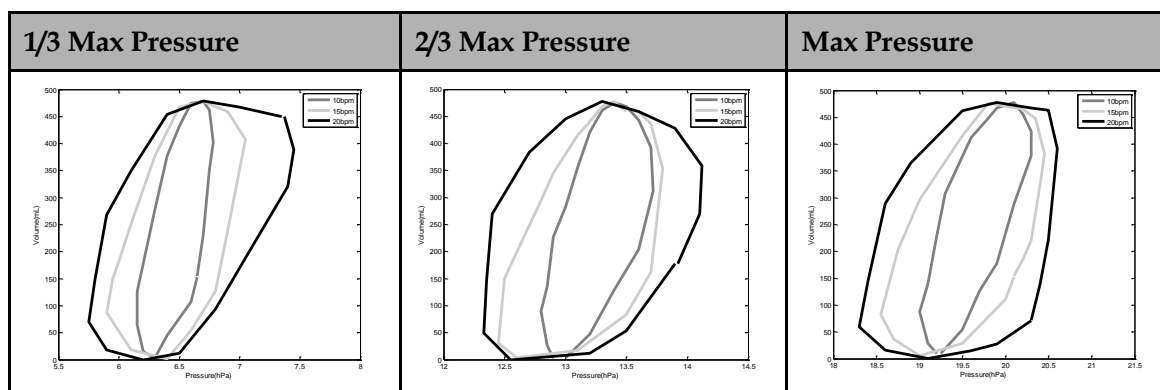

### Maximum Dynamic Pressure Variation (CPAP Mode)

**CAUTION**

- It will increase the range of pressure if you open the Xlief function.

Pressure (hPa)	Pressure Variation Range (hPa)		
	10 bpm	15 bpm	20 bpm
7.0	0.5	1.2	1.7
14.0	0.5	1.2	1.7
20.0	0.5	1.2	1.7

### Mask

Mask materials: Medical Silica Gel Material.

The mask specifications are as follows.

Mask	Pressure (cmH <sub>2</sub> O)	Air Leakage (L/min)
Nasal mask	4	20 ± 5
	10	50 ± 10
	20	60 ± 10
	30	80 ± 10
Full Face mask	4	25 ± 5
	10	40 ± 10
	20	60 ± 10
	30	75 ± 10
Nasal Pillow mask	4	25 ± 5
	10	35 ± 10
	20	45 ± 10

# Appendix B Key Components

No.	Key Components	Technical Data
1	Plug	250V, 2.5A
2	Supply cord	2×0.75 mm <sup>2</sup>
3	Connector	250V, 2.5A
4	Adapter	100V - 240V, 50 - 60 Hz, 1.5A Output: 24VDC, 3.0A, Tam: 40 °C
7	Motor	24VDC, 1200mA
8	Heating element	24V, 24W
9	Thermal cut-out for heating element	To: 75°C
10	LCD panel	36.72 (H) × 48.96 (V) (2.4 inch), TFT active matrix, 262K, 240(RGB) × 320, Operating Temperature: -20 °C to 70 °C
11	Tube	Diameter: 22 mm
12	Mask	S, M, L
13	Air filter	Most penetrating particle size : 10 μm

# Appendix C Terms

---

AI	Apnea Index
HI	Hypoventilation Index
IPAP	Inspiratory pressure
EPAP	Expiratory pressure
AHI	Apnea Hypoventilation Index
APAP	Automatic Continuous Positive Airway Pressure
AVAPS	Average Volume Assured Pressure Support
CPAP	Continuous Positive Airway Pressure
OSA	Obstructive Sleep Apnea
OSAS	Obstructive Sleep Apnea Syndrome
P95	The maximum pressure at which the device operates for 95% of the treatment time. P95 is considered to be the appropriate treatment pressure.
ALT Comp.	Altitude Compensation
Xlief	Expiration Relief

# Appendix D EMC Requirements

Guidance and manufacture's declaration - electromagnetic emission		
The CPAP Device <i>is</i> intended for use in the electromagnetic environment specified below. The customer of the user of the CPAP Device should assure that it is used in such an environment.		
Emission test	Compliance	Electromagnetic environment - guidance
RF emissions CISPR 11	Group 1	The CPAP Device use RF energy only for its internal function. Therefore, its RF emissions are very low and are not likely to cause any interference in nearby electronic equipment.
RF emission CISPR 11	Class B	The CPAP Device is suitable for use in all establishments, including domestic establishments and those directly connected to the public low-voltage power supply network that supplies buildings used for domestic purposes.
Harmonic emissions IEC 61000-3-2	Class A	
Voltage fluctuations/ flicker emissions IEC 61000-3-3	Complies	

Guidance and manufacture's declaration - electromagnetic immunity			
The CPAP Device is intended for use in the electromagnetic environment specified below. The customer or the user of CPAP Device should assure that it is used in such an environment.			
Immunity test	IEC 60601 test level	Compliance level	Electromagnetic environment - guidance
Electrostatic discharge (ESD) IEC 61000-4-2	±6 kV contact ±8 kV air	±6 kV contact ±8 kV air	Floors should be wood, concrete or ceramic tile. If floor are covered with synthetic material, the relative humidity should be at least 30%.
Electrical fast transient/burst IEC 61000-4-4	±2 kV for power supply lines	±2kV for power supply lines	Mains power quality should be that of a typical commercial or hospital environment.
Surge IEC 61000-4-5	± 1 kV line(s) to line(s)	±1 kV differential mode	Mains power quality should be that of a typical commercial or hospital environment.

<b>Guidance and manufacture's declaration - electromagnetic immunity</b>			
The CPAP Device is intended for use in the electromagnetic environment specified below. The customer or the user of CPAP Device should assure that it is used in such an environment.			
<b>Immunity test</b>	<b>IEC 60601 test level</b>	<b>Compliance level</b>	<b>Electromagnetic environment - guidance</b>
Voltage dips, short interruptions and voltage variations on power supply input lines IEC 61000-4-11	<p>&lt;5% <math>U_T</math> (&gt;95% dip in <math>U_T</math>) for 0.5 cycle</p> <p>40% <math>U_T</math> (60% dip in <math>U_T</math>) for 5 cycles</p> <p>70% <math>U_T</math> (30% dip in <math>U_T</math>) for 25 cycles</p> <p>&lt;5% <math>U_T</math> (&gt;95% dip in <math>U_T</math>) for 5 sec</p>	<p>&lt;5% <math>U_T</math> (&gt;95% dip in <math>U_T</math>) for 0.5 cycle</p> <p>40% <math>U_T</math> (60% dip in <math>U_T</math>) for 5 cycles</p> <p>70% <math>U_T</math> (30% dip in <math>U_T</math>) for 25 cycles</p> <p>&lt;5% <math>U_T</math> (&gt;95% dip in <math>U_T</math>) for 5 sec</p>	Mains power quality should be that of a typical commercial or hospital environment. If the user of the Ventilator requires continued operation during power mains interruptions, it is recommended that the Ventilator be powered from an uninterruptible power supply or a battery.
Power frequency (50Hz/60Hz) magnetic field IEC 61000-4-8	3A/m	3A/m	Power frequency magnetic fields should be at levels characteristic of a typical location in a typical commercial or hospital environment.
<b>NOTE:</b> $U_T$ is the a.c. mains voltage prior to application of the test level.			

Guidance and manufacture's declaration – electromagnetic immunity			
The CPAP Device <i>is</i> intended for use in the electromagnetic environment specified below. The customer or the user of CPAP Device should assure that it is used in such an environment.			
Immunity test	IEC 60601 test level	Compliance level	Electromagnetic environment - guidance
Conducted RF IEC 61000-4-6	3 V <sub>rms</sub> 150 kHz to 80 MHz	3 V <sub>rms</sub>	Portable and mobile RF communications equipment should be used no closer to any part of the CPAP Device, including cables, than the recommended separation distance calculated from the equation applicable to the frequency of the transmitter. Recommended separation distance $d = 1.167\sqrt{P}$ 150 KHz to 80 MHz
Radiated RF IEC 61000-4-3	3 V/m 80 MHz to 2.5 GHz	3 V/m	$d = 1.167\sqrt{P}$ 80 MHz to 800 MHz $d = 2.333\sqrt{P}$ 800 MHz to 2.5 GHz Where <i>P</i> is the maximum output power rating of the transmitter in watts (W) according to the transmitter manufacturer and <i>d</i> is the recommended separation distance in metres (m). Field strengths from fixed RF transmitters, as determined by an electromagnetic site survey, <sup>a</sup> should be less than the compliance level in each frequency range. <sup>b</sup> Interference may occur in the vicinity of equipment marked with the following symbol: 
<p><b>NOTE 1.</b> At 80 MHz and 800 MHz, the higher frequency range applies.</p> <p><b>NOTE 2.</b> These guidelines may not apply in all situations. Electromagnetic propagation is affected by absorption and reflection from structures, objects and people.</p>			
<p><sup>a</sup> Field strengths from fixed transmitters, such as base stations for radio (cellular/cordless) telephones and land mobile radios, amateur radio, AM and FM radio broadcast and TV broadcast cannot be predicted theoretically with accuracy. To assess the electromagnetic environment due to fixed RF transmitters, an electromagnetic site survey should be considered. If the measured field strength in the location in which the CPAP Device is used exceeds the applicable RF compliance level above, the CPAP Device should be observed to verify normal operation. If abnormal performance is observed, additional measures may be necessary, such as reorienting or relocating the CPAP Device.</p> <p><sup>b</sup> Over the frequency range 150 kHz to 80 MHz, field strengths should be less than 3 V/m.</p>			

Recommended separation distances between portable and mobile RF communications equipment and the Ventilator .			
The CPAP Device <i>is</i> intended for use in an electromagnetic environment in which radiated RF disturbances are controlled. The customer or the user of the CPAP Device can help prevent electromagnetic interference by maintaining a minimum distance between portable and mobile RF communications equipment (transmitters) and the CPAP Device as recommended below, according to the maximum output power of the communications equipment.			
Rated maximum output power of transmitter(W)	Separation distance according to frequency of transmitter(m)		
	150 KHz to 80 MHz $d = 1.167\sqrt{P}$	80 MHz to 800 MHz $d = 1.167\sqrt{P}$	800 MHz to 2.5 GHz $d = 2.333\sqrt{P}$
0.01	0.117	0.117	0.233
0.1	0.369	0.369	0.738
1	1.167	1.167	2.333
10	3.689	3.689	7.379
100	11.667	11.667	23.333
For transmitters rated at a maximum output power not listed above, the recommended separation distanced in metres (m) can be estimated using the equation applicable to the frequency of the transmitter, where P is the maximum output power rating of the transmitter in watts (W) according to the transmitter manufacturer.			
<b>NOTE 1.</b> At 80 MHz and 800 MHz, the separation distance for the higher frequency range applies.			
<b>NOTE 2.</b> These guidelines may not apply in all situations. Electromagnetic propagation is affected by absorption and reflection from structures, objects and people.			

# Appendix E Packing List

---

No.	Parameter	Quantity
1	Host	1
2	Air tubing	1
3	Nasal mask	1
4	Air Filter	2
5	SD card	1
6	User Manual	1
7	Warranty card	1
8	Carrying case	1
9	Quick Start Guide	1
10	CERTIFICATE	1
11	Packing List	1
12	Power cord, 1.5m	1
13	Power adapter	1



